

CANON CAMERA CO., INC.

3 Ginza 5-chome, Chuo-ku, Tokyo, Japan

CANON U.S.A., INC.

554 Fifth Avenue, New York, New York 10036, U.S.A.

CANON S.A. GENEVE

1, Rue de Hesse, 1204 Geneva, Switzerland

CANON LATIN AMERICA S.A.

Apartado 7022, Panama 5, Panama

PUB. NO. 5206F

0866D4

PRINTED IN JAPAN



Canon
demiS
I N S T R U C T I O N S



English Edition

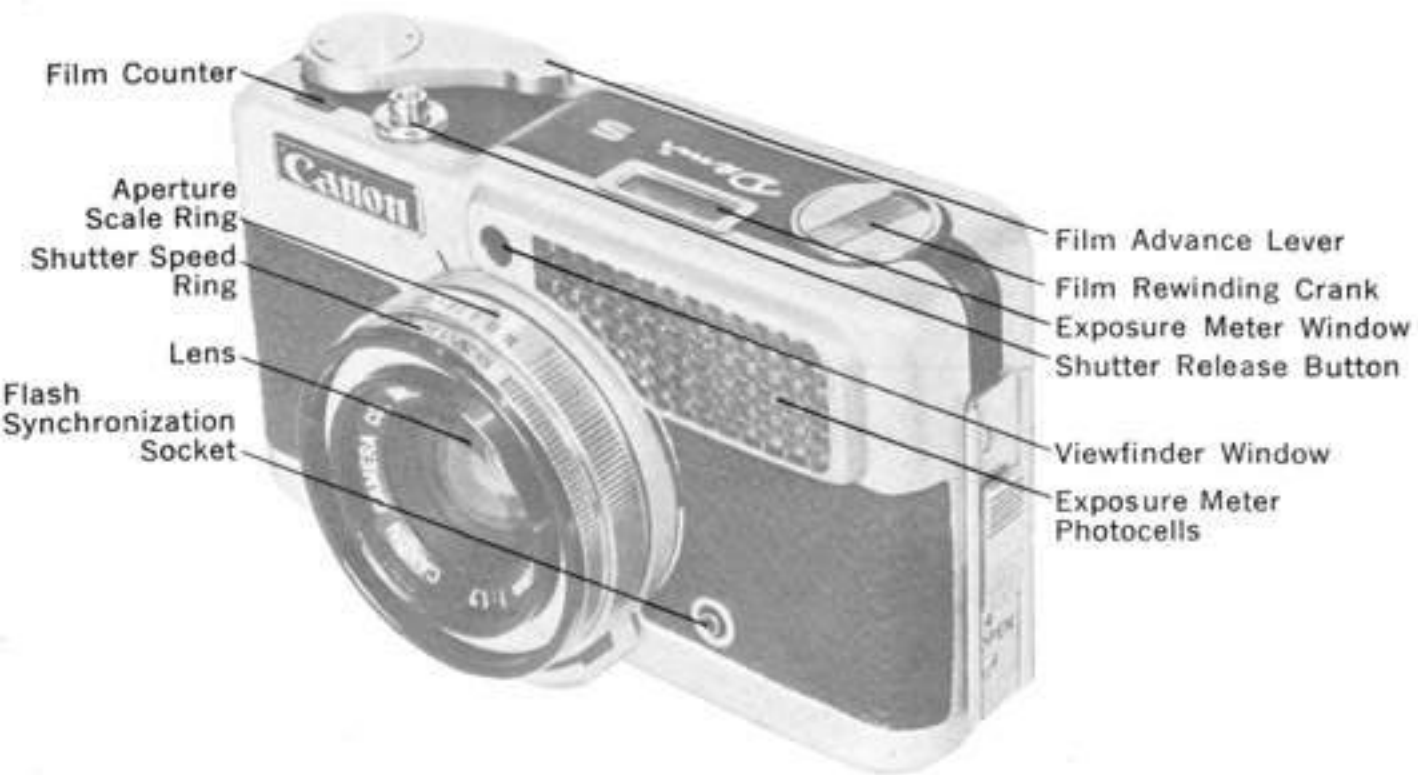

CANON DEMI S is a single-frame 35mm camera made by Canon's world renowned precision camera manufacturing techniques. Small enough to hold in the palm of your hand, sharp lens and designed for easy handling—these are the three most outstanding features of new DEMI S.

To get the most out of this camera, from ordinary snapshots to high-level photography, please read this instruction manual thoroughly.

Follow These Simple Steps...



Load the film.
p. 21



Set the film speed.
p. 12

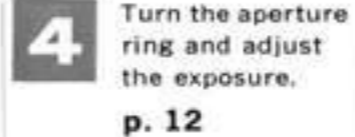
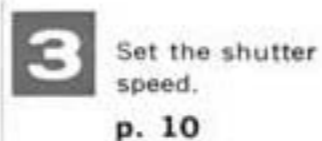
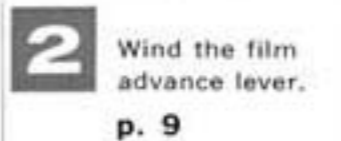

Canon Demi S Features

Easy-to-Handle Camera:

DEMI S is of unique round shaped design to fit snugly into anyone's hand. Many parts have been specially designed to make the camera slim, easy-to-handle, and convenient for carrying around.

Specially Designed Lens:

Made up of 6 elements in 4 components, Gauss type 30mm F 1.7 lens is fast and sharp. It has been specially designed for rigid aberration correction so that enlarged pictures can be obtained with the same quality as those from ordinary 35mm size film. Therefore, the extravagant lens system includes four newly developed glasses.

Helicoid Focusing:

Focusing is of the straight forward helicoid type where the entire lens system protrudes out. Unlike the front lens revolving type, the best performance possible can always be obtained from the lens with this type focusing.

High Performance Shutter:

High efficient shutter with speeds of 1/8—1/500 sec., and B.

Extravagant Prism Viewfinder:

The viewfinder, made up of four lenses and three prisms, is one of the easiest-to-see, actual upright image type viewfinders. It is also very accurate with minimum parallax.

Matching Needle Type Exposure Meter Coupled to Aperture:

Simple and appropriate system has been adopted in order to make full use of fast lens and high performance shutter. Under this system the aperture stops can freely be set against the various shutter speeds.

Other Easy-to-Manipulate Features:

The zone focusing system and the easy-to-wind film advance lever greatly contribute to the easy-to-manipulate features of CANON DEMI S which incorporates many of the fine mechanical features found in expensive high quality cameras.

Specifications

Type:	Single-frame 35mm camera. Picture size 24×18 mm.
Lens:	Canon Lens SH 30mm F1.7 Gauss type lens made up of 6 elements in 4 components.
Coating:	Spectra hard coated in umber.
Angle-of-view:	53°
Aperture Stops:	1.7 2.8 4 5.6 8 11 16
Focusing:	Zone focusing system with helicoid adjustment.
Exposure Meter:	Shutter-speed-priority, matching needle type exposure meter coupled to aperture stops.
Working Range of Exposure Meter:	EV 4.5-17.
Film Speed Graduations:	(32-40) (64-80) (125-160) (250-320)
ASA	25 · 50 · 100 · 200 · 400
DIN	15 · 18 · 21 · 24 · 27
	(16-17) (19-20) (22-23) (25-26)
Shutter:	Lens shutter type, 1/8-1/500 sec. and B.
Flash Synchronization:	X contact. Fully synchronizes with speedlight. M and F class bulbs can be used.
Viewfinder:	0.41×. Actual upright image viewfinder of Kepler type.
Film Advance Lever:	Single stroke winding with 145° revolving angle. Additive windups possible.
Film Counter:	Self-resetting type.
Size:	115 mm×68 mm×48 mm (4½"×2½"×1¾")—body only.
Weight:	400 grams (14 oz.)
Accessories:	34 mm screw-in type filters, Flash Unit Coupler, Flash Unit J-3, Flash Quint, Canon Release, Selftimer 6.

2

How to Wind Film Advance Lever

1. When the film advance lever is wound, the shutter is charged and the film is advanced one frame.
2. Next, when the shutter button is pressed, the shutter is actuated and the film advance lever can once more be wound.

- * The film counter advances after every second winding.
- * Additive windups of the film advance lever are possible.
- * Do not wind the film while pressing the shutter button. The shutter will be released simultaneously with the wind up.



3 Shutter and Aperture

Opening the shutter and exposing the film to light is called exposure. The shutter and aperture control the exposure. The shutter controls the exposure time and the aperture controls the amount of light. CANON DEMI S is designed so that proper exposures can easily be obtained with the coupled exposure meter.



Shutter Speed Ring

To adjust the shutter speed, turn the shutter speed ring and set the desired shutter speed at the index. The shutter speed scale on the shutter speed ring are engraved with the denominators of such speeds as 1/500 sec. and 1/250 sec.

- * The shutter speed are engraved in such a way that as each succeeding graduation figure grows larger the exposure time becomes shorter by one-half.
- * B is for bulb exposure and is used when taking pictures with long exposure time. The shutter stays open as long as the shutter button is pressed, and closes when the button is released. (Refer to Page 27.)

Aperture

As the aperture stop gets larger, the light volume decreases. The aperture stops are engraved in such a way that as each succeeding aperture stop grows larger the light volume decreases by one-half. Therefore, if the aperture is closed one stop, the exposure time must be doubled, and if the aperture is closed two stops, the exposure time must be extended four times. The aperture can also be set at positions between the aperture stops.

- * With its built-in exposure meter, the correct aperture stop to the shutter speed can easily be determined.
- * The ratio between aperture and the amount of exposure, using F2 as the basis, is as follows:

Lens Aperture	1.7	2	2.8	(3.5)	4	5.6	8	11	16
Exposure Ratio	1/1.38	1	2	(3)	4	8	16	32	64

1. Set the Film Speed.

Press the film speed set lever slightly and turn with a fingernail to set the film speed of the film used.

- If this is not done, photography with coupled exposure meter will not be possible. It is best to set the film speed immediately after loading the film.

Turn the set lever with slight pressure.



- The set lever is set at the film speed index with click stops.
- Each film speed is indicated on the film box or instruction sheet.
- Film speeds are indicated in ASA and DIN. The black dots in between indicate the following figures.

ASA	25	$\frac{32}{40}$	50	$\frac{64}{80}$	100	$\frac{125}{160}$	200	$\frac{250}{320}$	400
DIN	15	$\frac{16}{17}$	18	$\frac{19}{20}$	21	$\frac{22}{23}$	24	$\frac{25}{26}$	27

2. Determine the Shutter Speed.

Turn the shutter speed ring and set the desired shutter speed at the index.

- It will be convenient to remember to set the shutter speeds in the following manner :
 Bright sun250
 Sunny125
 Cloudy 60
 Rainy/Indoors 30
- CANON DEMI S is a shutter speed priority type camera. Therefore, it is easier to use by setting the shutter speed first.
- When the aperture stop at both ends is set at the aperture index, the camera is designed so that the shutter ring and the aperture ring revolve simultaneously.

3. Determine the Correct Aperture.

When the camera is turned toward the photographic subject (the object to be

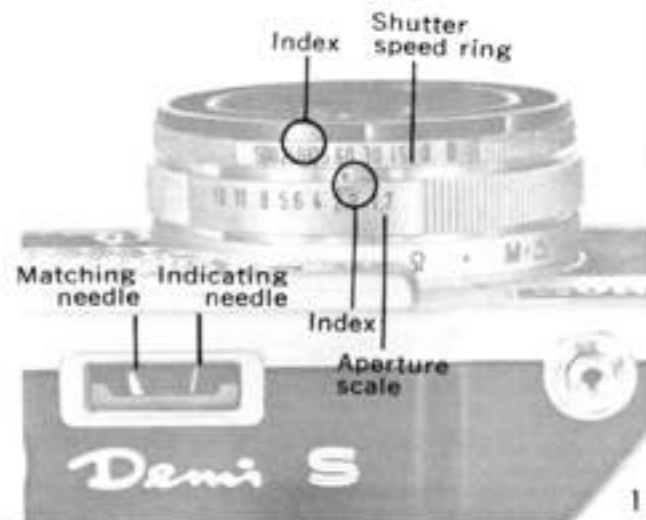

photographed) the exposure meter needle will move according to the brightness of the subject. Then, turn the aperture ring and align the matching needle (thick needle) over the indicating

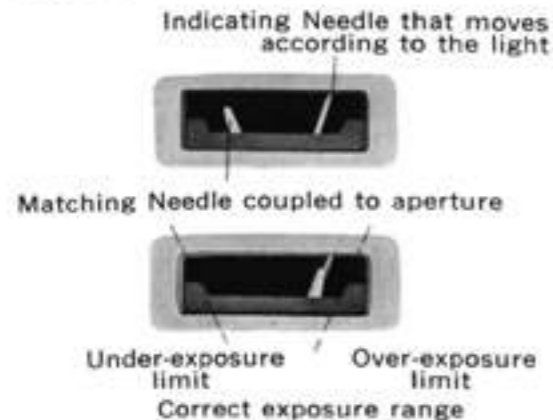

needle (fine needle) and the aperture will be set to the correct aperture stop automatically. Exposure adjustment is completed with this operation.



- The aperture stop that has been set can be read against the index on the aperture ring.
- When the indicating needle goes into the under-exposure or over-exposure limit areas on both sides, photography coupled to the exposure meter is not possible.
- When the indicating needle moves over to the far right it indicates over-exposure. In this case, use an ND filter to reduce the film sensitivity. (Refer to Page 32.)
- When the indicating needle moves over to the far left it indicates under-exposure. In this case, switch to flash photography or B (bulb) exposure.
- The aperture index moves according to changes in the shutter speed.

4. Correct Improper Shutter Speed Setting.

Turn the aperture ring as far as it goes. In case the matching needle does not align with the indicating needle, turn the aperture ring further until it does. The shutter ring will then revolve simultaneously with the aperture ring, which means that correct exposures can now be obtained.

- For example, this is applicable in cases where the shutter speed is not set properly, such as, at 1/8 sec. when photographing outdoors in the daytime or at 1/500 sec. in a dark room.

- When turning the aperture ring, do so within the range of keeping the matching needle of the exposure meter from entering the improper exposure areas. It must be noted that when the aperture ring is turned to the extent that the matching needle enters the improper exposure area, the film speed set lever will be out of position when films with low sensitivity are used. Also, when the aperture ring is inadvertently turned, reset the ring and check to see that the ring is properly set.

5. Combining of Shutter Speed and Aperture Stop.

If only the shutter ring is turned, after setting the camera to the proper exposure, the combination of shutter speed and

aperture stop can be changed while maintaining a proper exposure. In this case, the shutter speed must be set within the range of not moving the aperture ring. If the aperture ring should move, the exposure meter matching needle will move and proper exposure cannot be maintained.

- Be careful not to cover the exposure meter photocells with your hand when measuring the light quantity of the subject.
- B (bulb) cannot be used for photography with exposure meter since it is used for taking long-exposure pictures.
- Be careful not to face the camera skyward when reading the exposure meter indicating needle.

- When taking pictures with such bright scenes as the sea or sky in the background or when taking pictures against the light, the subject tends to become under-exposed. In such cases, measure the light quantity near the subject or measure by slightly facing the camera downwards. Another effective method is to reduce the film speed by approximately one graduation.
- Manual aperture photography is possible when the exposure meter is not used.



Focusing Lever

After the exposure has been determined, the next step is to get the subject into correct focus. When photographing, the lens must always be adjusted according to the distance from the camera to the subject (the object to be photographed).

1. Choose, among the three zone focusing marks on the focusing ring, the mark which appropriately indicates the distance from the camera to the subject.
2. Turn the focusing ring and set the desired focusing mark at the index. With this manipulation you can get the correct focused subject.

- The lens of CANON DEMI S has a deep depth-of-field. Therefore, sharp and clear pictures can be obtained with only the above-mentioned manipulation.
- There are three black dots on the focusing ring besides the three marks. The photographing distances that these marks indicate are shown on the distance table on the back cover of the camera.

Distance Table

	•	♀	•	H	•	▲	
m	0.8	1	1.5	3	5	15	CA
ft	2.6	3	5	10	15	50	

- Even when photographing only one person, use the medium distance mark if the distance to the subject is long.

Zone Focusing Marks



Index



The viewfinder determines the photographing scope. The viewfinder of CANON DEMI S is located directly above the lens and so the entire composition of the picture to be shot will appear.



Press the shutter button gently after deciding the composition of the picture.

1. Hold the camera firmly.
2. Keep an elbow against your body.
3. Press the shutter button with a smooth, steady stroke.

How to Load Film

Use ordinary 35mm film in cartridge.

1. Slide the back cover lock downwards and open the back cover of the camera. The film counter will automatically re-set itself to S (starting position).
 2. Insert the film cartridge into the cartridge holder.
- The rewinding crank is designed so that it cannot be pulled upwards. Insert the cartridge from the bottom part of the camera body. Push the fork into the axis of the film cartridge.
3. Wind the film advance lever or turn the film take-up-spool in the direction of the arrow so that the groove

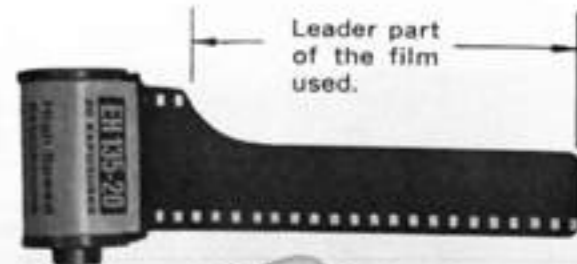

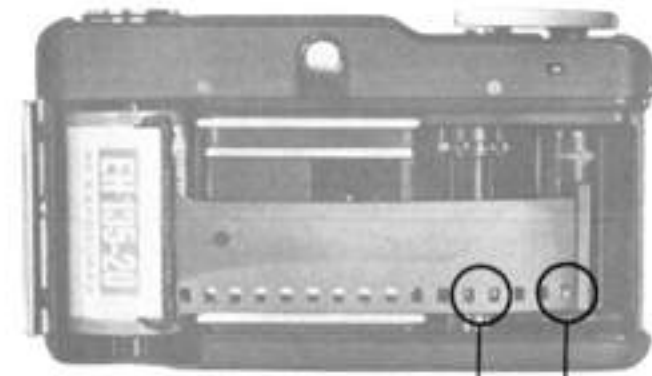
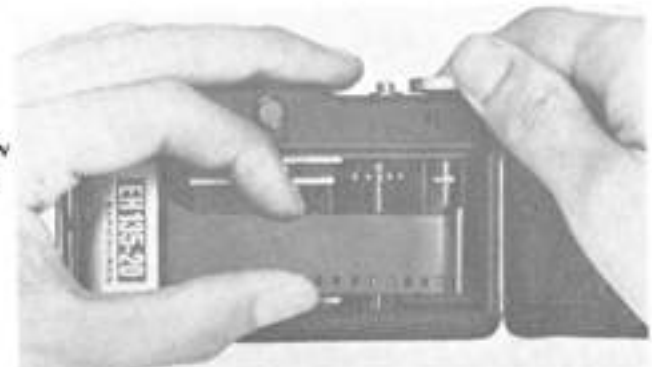
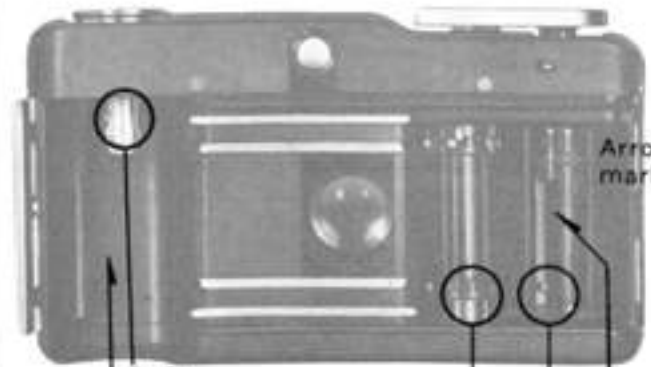

- of the spool appears on top. Insert the leader part of the film fully into this groove.
4. Simultaneously, engage the film perforation with the projection.
 5. Again wind the film advance lever or turn the spool and wrap the film around the spool. Next, after taking the slack out of the film, check to see whether the film perforations have accurately caught onto the sprocket.

6. Close the back cover. The back cover is completely locked by just pressing it lightly.
7. Wind the film advance lever and press the shutter button.
8. Repeating this operation, when the film counter indicates 0, the first frame is now ready for exposure.



From S to 0.

* After the film has been loaded, the first windup sometimes results in turning without winding the film. So, it is best to always make another windup.

Checking for Correct Film Loading

The film is correctly loaded if the rewinding crank revolves simultaneously with the movement of the lever. However, if the film should be loose inside the film cartridge the rewinding crank sometimes will not turn. In this case, turn the rewinding crank clockwise two or three times to take the slackout of the loaded film. Reload the film when it is not loaded correctly.

How to Rewind Film

Since no further winding is possible when the end of the film is reached, rewind the film immediately into the original cartridge, as explained below. As the exposed film is naked within the camera, the entire roll will be ruined if the cover is opened before rewinding.

* If winding is continued even after the end of the film is reached, the film will tear and cannot be returned into the cartridge. In this case, the film must be put back into the cartridge in a completely dark room.

1. Lift up the rewinding crank. The entire knob will slightly rise.
2. While pressing the film rewinding button located on the base plate





of the camera, turn the rewinding crank in the direction of the arrow. Stop rewinding when resistance becomes light.

3. Return the rewinding crank back into place. After folding the knob, lightly press the entire crank and it will fit back into its former position. (The crank will not be back if it is pressed without folding the knob.)
4. Open the back cover.
5. Unload the cartridge.



Bulb Photography/Long Exposure Photography



adjusted. This method is used when photographing fireworks, night scenes and stars.

1. Turn the shutter speed ring and set B at the index.
2. Set the aperture stop.
3. Press the shutter button.

- * The exposure meter does not couple during B exposure.
- * Always use a tripod and cable release during B exposure.
- * For very long exposures, use a cable release with lock.

In B (Bulb) photography the shutter remains open and the film exposed as long as the shutter button is pressed. In this way, exposure time can be freely

Flash Photography

Flash is used when the subject to be photographed is under poor lighting conditions and photography with coupled exposure meter is impossible. In this case, the aperture is set manually.

Synchronizing Scope

Flash Bulb	Scope of Synchronization
Speedlight	All shutter speeds
M Class F Class	Shutter speeds of under 1/30 sec.

CANON DEMI S has an X setting which synchronizes according to the above chart.

1. Attach the flash unit coupler by sliding it into the mounting shoe.
2. Attach the flash unit onto the accessory shoe of the coupler and plug the cord into the flash socket.



- * When using Flash Unit J-3 with CANON DEMI S, be sure to mount a baseless AG or PH type adapter and to use a small baseless bulb.
- * When using a swan base type big sized bulb, be careful of the appearance of a ghost image.



3. Focus and obtain the photographing distance. For accurate photographing distance, refer to the distance table on the back cover of the camera.

- * When Flash Unit J-3 is used, bothersome calculations are not necessary because it has the calculating plate.
- * The flash of the speedlight is of very short duration and gives determined exposure with no relation to shutter speed. Therefore, there is no need for changing the aperture stop because of the shutter speed.

4. Set the aperture stop to the aperture ring.

The aperture stop is calculated by dividing the guide number of the flash bulb with the distance.

$$\text{Aperture} = \frac{\text{Guide number of a bulb}}{\text{Distance}}$$

- The guide number differs according to the flash bulb. It is printed on the package and is necessary for deciding the aperture stop.
- The guide number changes according to the film speed and the type of film. The guide numbers are indicated in meters and feet.

How to Use Filters

Filters are attached to the front frame of the lens by screw-in method. Filters give special effects on monochrome and color films. Under conditions of over-exposure, ND filters are used to adjust the exposure.

Filters have exposure factors according to density and type. When using a filter the exposure must be adjusted according to the exposure factor. Correct exposures cannot be obtained if the following adjustments are not made.



Adjustment Method 1

Changing the film speed

1. Divide the film speed of the film being used by the exposure factor of the filter.
2. Correct the film speed to the numerical value thus obtained.

Example: If the film speed is ASA 100 and the exposure factor is 2, then it is $100 \div 2 = 50$. In other words, the film speed must be adjusted to ASA 50.

After the film speed has been adjusted, ordinary exposure adjustments are made.

Adjustment Method 2

Adjusting aperture and shutter

1. First make the ordinary exposure adjustments.
2. Then adjust either the aperture stop or the shutter speed according to the exposure factor. The graduations of both the aperture and shutter are in a multiple relation. If the exposure factor is 2, the exposure is increased by 1 graduation. If the exposure factor is 4, the exposure is increased by 2 graduations.

34 mm Screw-In Type Filters

Exposure Factor	Type	
1	UV (SL 39.3C)	For monochrome and color
1.5	Y1 (SY 44.2C)	For monochrome
2	Y3 (SY 50.2C)	
3	O1 (SO 56.2C)	
6	R1 (SR 60.2C)	For monochrome and color
3	G1 (MG 55C)	
1	Skylight	For monochrome and color
4	ND 4	
8	ND 8	
2	Color Conversion A	For color
3	Color Conversion B	

Effectiveness of Filters

- Absorbs only ultra-violet rays. Especially effective at seaside and high mountains. Recommended for use in color photography.
- Increases contrast of monochrome film. Slightly brightens red and yellow.
- Good for contrasts, especially in distant landscapes.
- Makes strong contrasts. May also be used with infrared film.
- Makes strong contrasts. May also be used with infrared film.
- Prevents red from turning radically into white. Lightens faces and sky appropriately, and reflects the brightness of fresh greenery as seen with the naked eye.
- Acts to harmonize the blue sky and shade.
- ND 4 reduces light volume by 1/4, ND 8 by 1/8. Has absolutely no effect on the reproduction of colors of color film.
- Color film filter for conversion of color temperature when photographing tungsten type film under sunlight.
- Color temperature conversion filter for use with daylight type color film under tungsten light.

Important Note

Please observe the following points in handling so as to get the most out of your CANON DEMI S.

1. When using the self-timer, attach the self-timer onto the camera and wind it up before winding the film advance lever.
2. When you open the back cover of the camera, please do not touch the lens shutter diaphragm and keep it free being scratched.
3. Make sure that the wrist strap is securely attached to the camera so that you do not drop the camera. Securely screw it in with a coin.



Maintenance and Proper Care of Canon Demi S

High temperature and moisture are harmful to a camera. Do not keep the camera in a closed drawer or in a darkroom with many chemicals for a long period of time.

Care of Camera

When the camera is used outdoors it is likely to gather dust. When it is used on a rainy day, or at the beach, moisture and salt air adhere to it, which can result in stains, rust and corrosion to the camera and lens. Use a soft brush to brush away the dust and a dry soft cloth for wiping. It is best not to use oils, and is also advisable not to clean the camera and lens with sweaty fingers.

Care of Lens

It is best not to touch the lens. Brush the lens lightly with a soft brush or feather. If you should inadvertently get a fingerprint on the lens and it cannot be removed with a brush, follow the proceeding procedure. Wrap a clean and soft cotton cloth around a matchstick and put a little alcohol (a small quantity of ether may be mixed) on the tip to the degree that it is slightly moistened. Wipe the lens lightly and gently in a circular motion from the center towards the outer edges. The ideal condition is for the alcohol to dry up while the wiping continues. Never wipe the lens roughly or with dusty cloth because it will scratch the lens.

Accessories

● Flash Unit J-3



With a built-in convertible socket for AG and PH. Exclusively for baseless bulbs.

● Flash Quint



Five bulbs can be flashed continuously. AG type bulb only.

● Canon Release



● Flash Unit Coupler



● Selftimer 6



Distance Table
Back Cover
Opening-Closing
Knob

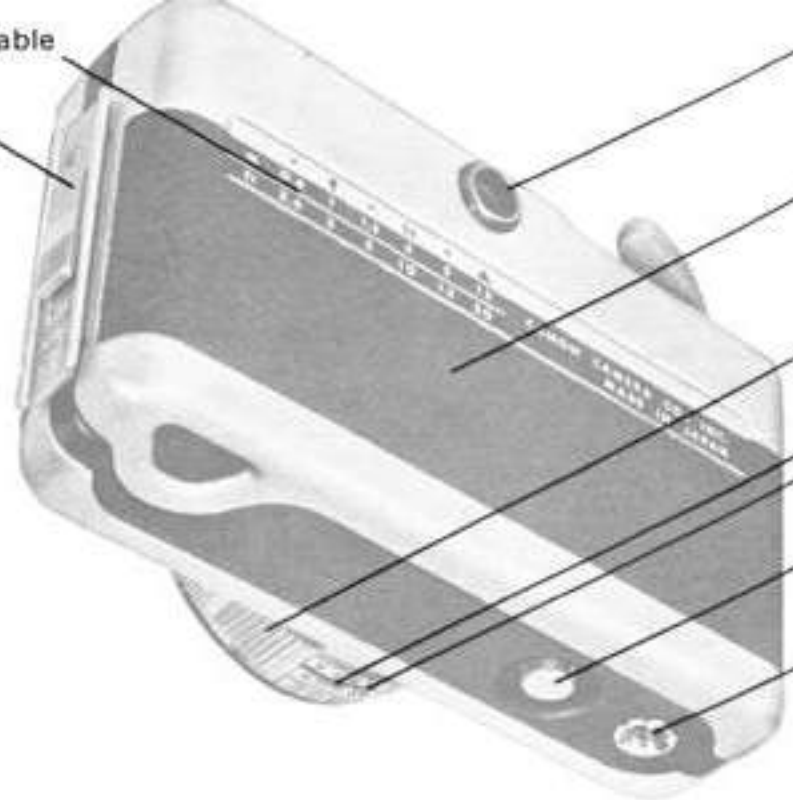

Viewfinder Eye-Piece

Back Cover

Focusing Lever

Film Speed
Set Lever

Film Speed Scale

Film Rewind
Button

Tripod Socket